

Click object to rotate

Mono



Single Monoblock 23mm LNB ,6° for 80cm dish

IDLB-SINM22-MN006-8PP

Item: 5018

This monoblock LNB was designed for dual satellite reception. It can be used for the broadcast reception of any two satellites, spaced with 6° on an 80cm dish antenna, and its distribution to a single tuner Set-top box. It is optimized for High Definition transmissions, provides excellent Noise Figure performance and manufactured to the highest industry quality standards.

Main Features:

- Low phase Noise HDTV-DVBS2 compliant
- Low Noise figure of 0.2 dB
- Low Power consumption
- Very high Cross-Pole performance
- Very high Frequency stability

Technical data

Low Band Input Frequency Range	110.7 ~ 11.7 GHz
Low Band Output Frequency Range	950 ~ 1950 MHz
Low Band LO Frequency	9.75 GHz
High Band Input Frequency Range	11.7 ~ 12.75 GHz
High Band Output Frequency Range	1100 ~ 2150 MHz
High Band LO Frequency	10.6 GHz
Noise Figure	0.2 dB Typ. (0.7 dB Max.)
LO Initial Accuracy	+/- 1.0 MHz Max.
LO Temperature Drift	+/- 3.0 MHz Max.
Phase Noise (@ 10 kHz)	- 90 dBc / Hz Max.
Conversion Gain	50 ~ 62 dB
Gain Ripple (Over 26 MHz Bandwidth)	+/- 0.75 dB
Gain Variation (Over Full Band)	+/- 4 dB Max.
Image Rejection	40 dB Min.
1 dB Compression Point (@ Output)	0.0 dBm Min.
Control: Satellite A/B Selection	DiSEqC 1.0 (Sat A* = Hotbird 13° East, Sat B = ASTRA 19.2° East)
Cross Polarization Isolation	22 dB Min.
Output VSWR	2.5 : 1
In-Band Spurious	- 60 dBm Max.
Current Consumption	150 mA Max. @ 11 ~ 20 V
Operating Temperature	- 30 °C ~ + 60 °C
Output Impedance	75 Ω
Output Connector	F-Type (Female)
Weight	270 g
Recommended Dish Size	75 ~ 85 cm (F/D = 0.6)
Monoblock Mounting Bracket	23 mm

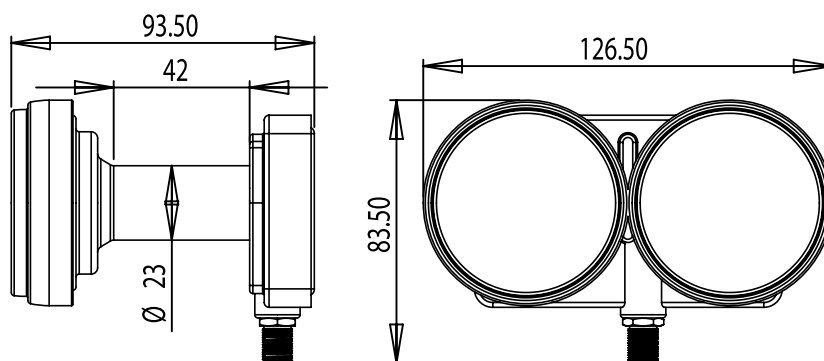

For purpose of brevity, some product descriptions in this sheet remain at platform level and may not be referred to as detailed datasheets of the products. Inverto Digital Labs reserves the right to amend, omit or add products, product-lines, and / or features without notice.

For further details contact: sales@inverto.tv

FTA Communication Technologies S.a r.l Tel. +352 264 367 1 Fax. +352 264 313 68

